

Specifications

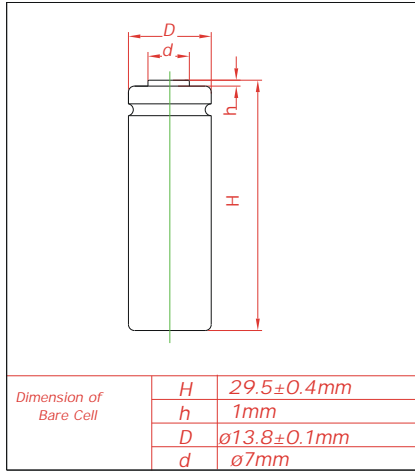

Nominal Capacity		300mAh		
Nominal Voltage		1.2V		
Cycle life		>500		
Charge	Standard	30mA	15h	0-45°C
	Quick	90mA	5h	5-45°C
	Fast	300mA	1.1h	10-45°C
Discharge		-20°C~65-20°C		
Storage				
Internal Impedance(AC) (After Charge)		30m Ω		
Weight		13.5g		

Charge

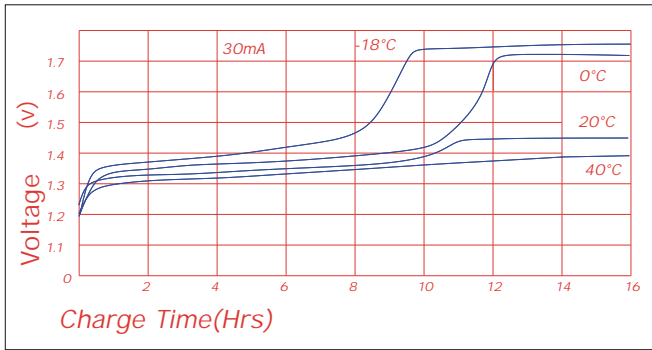

Discharge(at high rate)

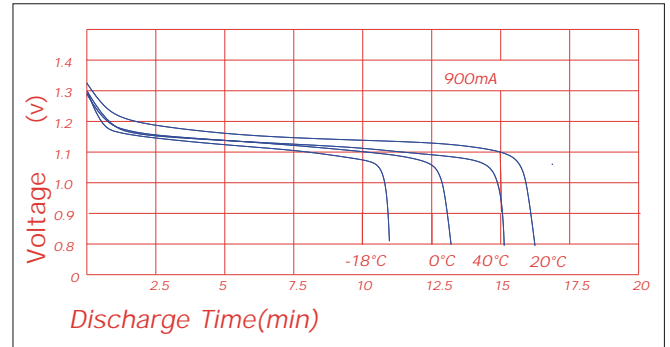

Discharge (at low rate)

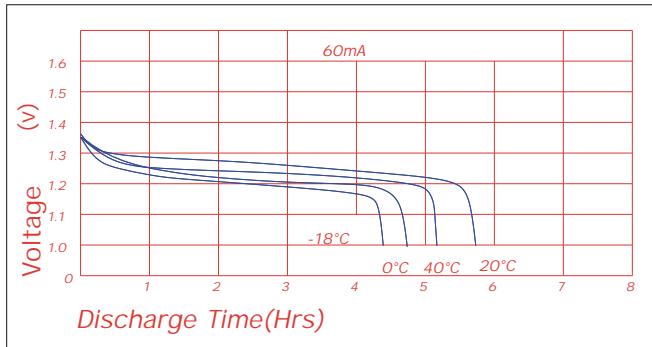

Discharge(at high rate)

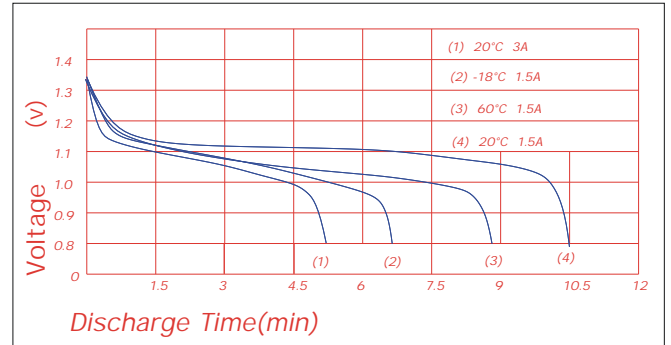

Discharge(at high rate)

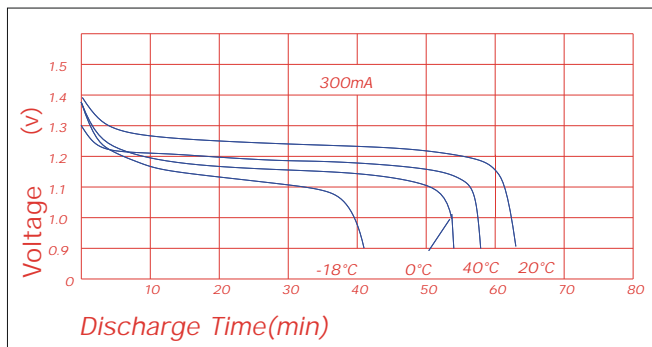

Charge Retention

